



LGMG

MOBILE ELEVATING WORK PLATFORMS



LINGONG GROUP JINAN HEAVY MACHINERY CO., LTD.

Address: No. 2676, Kejia Road, Jinan, Shandong, China
Email: sales@lmg.com.cn
Tel: +86-0531-67879283
Web: www.lmglifts.com

LGMG Europe B.V.

Address: Laanweg 16 3208LC Spijkenisse Rotterdam, The Netherlands

LGMG North America, Inc.

Address: 1445 Sheffler Dr, Chambersburg, PA. 17201, USA



www.lmglifts.com

Please contact LGMG or local dealer for more details.
LGMG reserve the right to change technical data without prior notice. All photos and pictures in this brochure are for promotional purpose only.
This brochure comes into effect in January, 2022.

RELIABILITY IN ACTION



CONTENTS



P3-4

GROUP PROFILE

P11-20

ELECTRIC MOTOR DRIVE

- ✦SS0407E SS0507E SS0607E
- ✦SS0407ER SS0507ER SS0607ER
- ✦AS0607E AS0607WE AS0608E AS0808E
- ✦AS0812E AS1012E AS1212E
- ✦AS1413E

P25-30

ROUGH TERRAIN SCISSOR LIFT

- ✦SR0818E SR1018E SR1218E
- ✦SR0818D SR1018D SR1218D
- ✦SR1023D SR1323D SR1623D

P37-40

TELESCOPIC BOOM LIFT

- ✦T22J
- ✦T20J T26J

P5-10

R&D, MANUFACTURING, GLOBAL SALES NETWORK

P21-24

HYDRAULIC MOTOR DRIVE

- ✦AS0607 AS0607W AS0608 AS0808
- ✦AS0812 AS1012 AS1212 AS1413

P31-36

ARTICULATING BOOM LIFT

- ✦A14JE
- ✦AR14J AR16J

P41-42

SERVICE & APPLICATIONS



GROUP PROFILE

Founded in 1972, Lingong Machinery Group is one of the key players in construction machinery, one of the top 100 enterprises in the machinery industry and one of the top four groups in the construction machinery industry in China.

The Group consists of three core companies, including: Shandong Lingong Construction Machinery Co., Ltd. (SDLG), Lingong Group Jinan Heavy Group's Co.,Ltd. (LGMG) and Lingong Special Machinery Co.,Ltd. The Group's business cover five sectors: construction machinery, mining machinery, MEWPs, special machinery and component manufacturing.

LGMG, located in Jinan, Shandong Province, China, is a privately-owned subsidiary of Lingong Machinery Group. Business segments include MEWPs, mining equipment. Today, LGMG has become an important player in the Chinese construction machinery industry. Holding a place as one of the top 100 global construction machinery manufacturers, the top 30 Chinese construction machinery manufacturers and the top 5 Chinese MEWPs manufacturers.

LGMG offers a wide range of electric and rough terrain scissor lifts, articulating and telescopic boom lifts.

In 2018, LGMG Europe was established in Rotterdam, the Netherlands to serve as a distribution and service hub for the EMEA market and in 2019, LGMG North America opened a headquarters in Pennsylvania together with other three locations across the country in Tennessee, Texas and California. In 2020, LGMG Japan was established, integrating marketing and technology research and development functions into one.

R&D TEAM

LGMG sees that R&D and innovation are key for sustainable growth, and has therefore established the Provincial Level Innovation, for new product development and component reliability tests. In addition, LGMG has collaborated with a top Chinese university to establish the LGMG Research institute, aiming to crack industry challenges and develop cutting edge technology, as well as have a profound effect on the cultivation on future talent for our industry.



GLOBAL SALES NETWORK

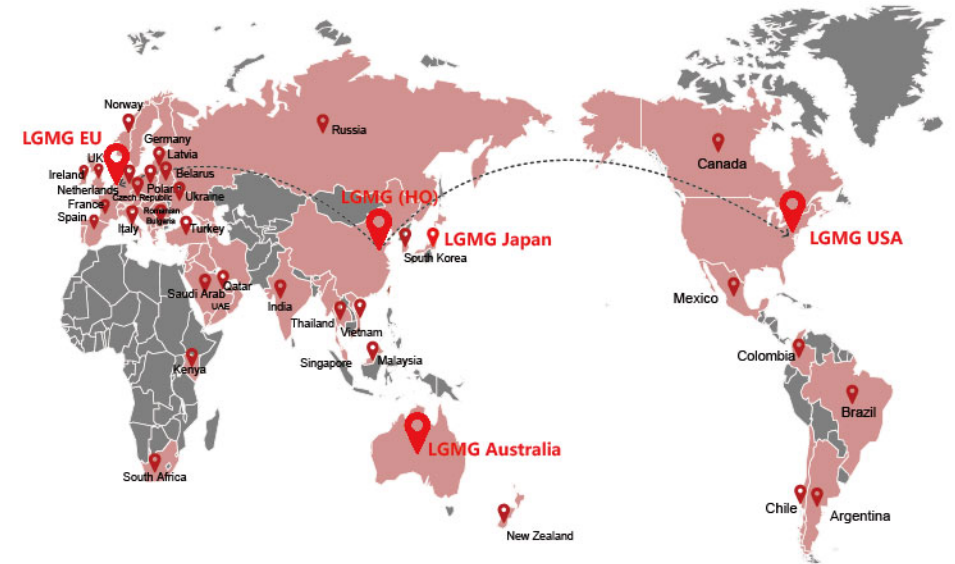

200+
PARTNERS

50+
COUNTRIES

- LOCAL TEAM SUPPORT**
- LOCAL MACHINE DELIVERY**
- LOCAL SPARE PARTS**
- LOCAL FAST AND HIGH QUALITY SERVICE**
- LOCAL TRAINING**



LGMG Europe.BV



LGMG North America, Inc

(LPS 6 PRINCIPLES)



MANUFACTURING

LGMG's manufacturing base covers an area of 350,000 square meters, with an annual production capacity of 40,000 MEWP units. From parts welding and painting, to machine assembling and final product inspection, each procedure is strictly aligned with LGMG's Lean Production System (LPS 6 PRINCIPLES) to ensure the highest production efficiency and the best quality.



The establishment of LGMG European, North American and Japan companies has ensured quick and effective response times which fully meets our customers' requirements on machine inventory, parts and support with local professional teams. LGMG products have passed the major international standards such as CE, ANSI, Australia AS, CSA, KC, JIS, EAC. Products have been sold to over 200 partners in more than 50 countries around the world, including U.S., Canada, UK, Germany, the Netherlands, Italy, Spain, Korea and Japan.

PRODUCT RANGE

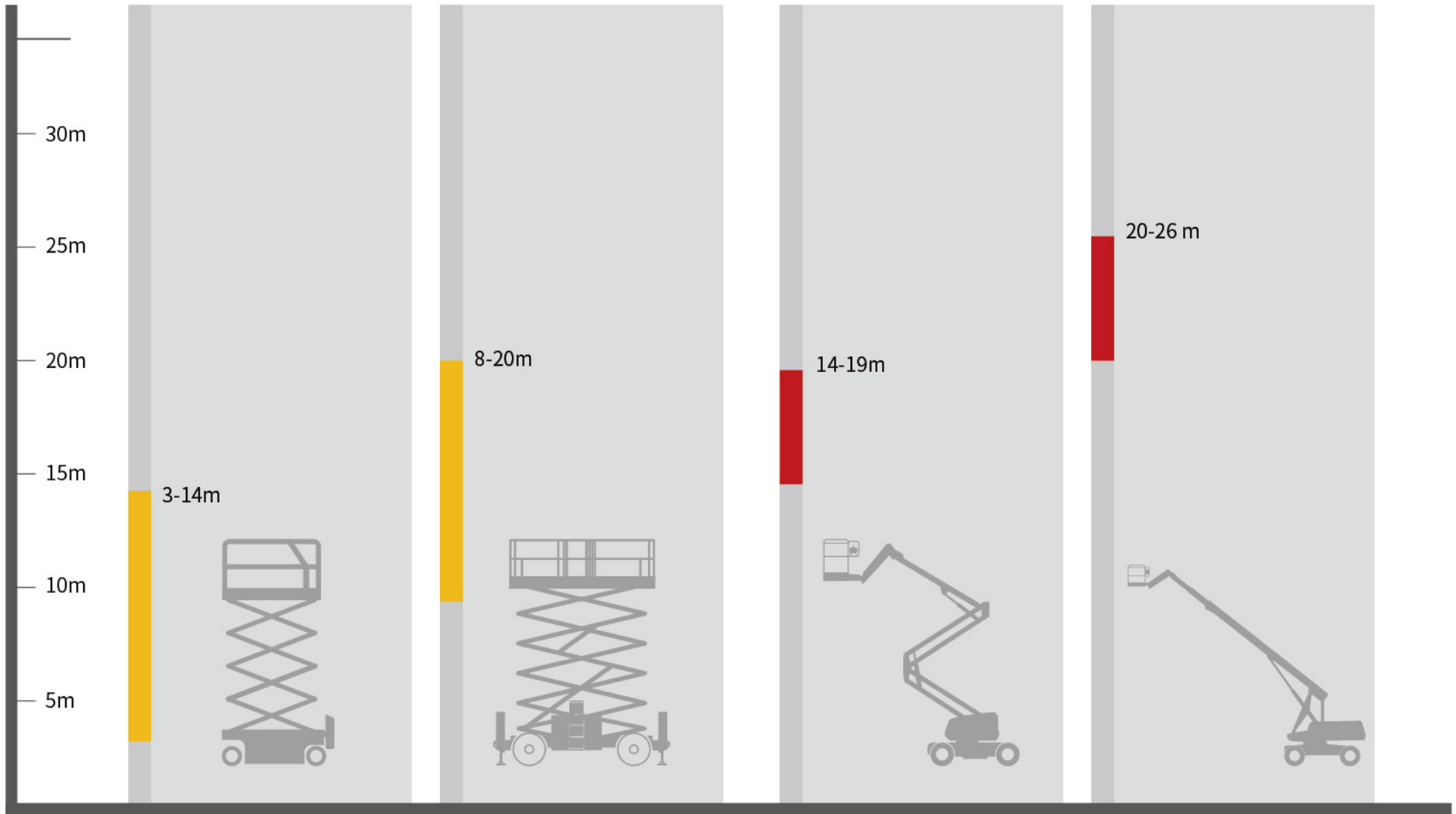

SELF-PROPELLED SCISSOR LIFT



PRODUCT CONFIGURATIONS

STANDARD FEATURES

- Proportional control
- Foldable guardrail
- Emergency stop device
- Manual brake release
- Emergency descent
- Swing-out component tray
- Pothole guard
- Self-lock entry gate
- Tilt alarm with lift cut-out
- Overload sensing system
- Descent alarm with flashing beacon
- Horn/hour meter
- All motions alarm
- Full-height drive
- Intelligent diagnostic system

OPTIONAL

- AC power to platform
- Maintenance-free battery
- Platform anti-collision device
- Air tube to platform
- Lithium battery
- GPS

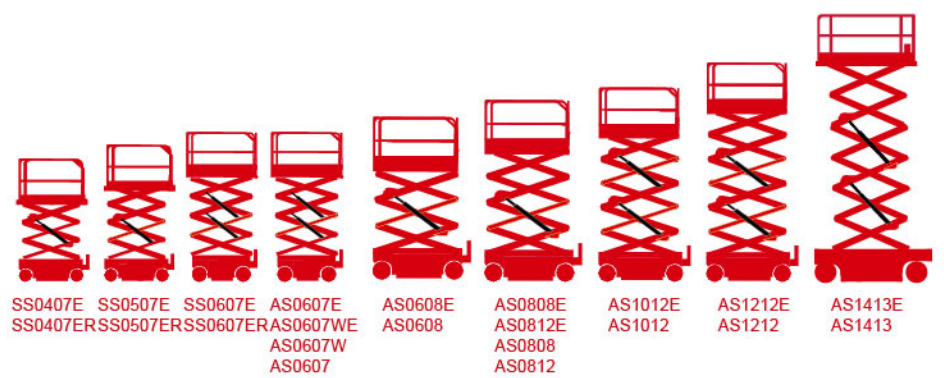
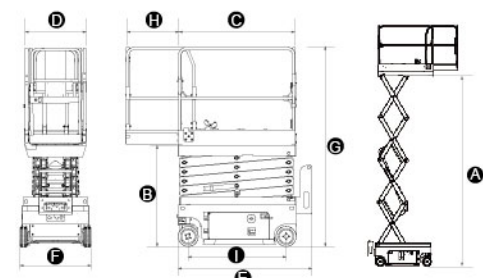

ELECTRIC MOTOR DRIVE SCISSOR LIFT

SS0407E (SS1230E) / SS0507E (SS1432E)

SS0607E (SS1932E)

SPECIFICATIONS



HIGHLIGHTS

LGMG SS Series scissor lifts offer an ideal solution for the low-level access and tight restricted application job sites. Shorter overall machine length and lighter weight makes it suitable for most elevators.

- Battery powered, zero emission and quiet drive mean this machine is environmentally friendly.
- Efficient electric drive system provides longer-lasting performance and better gradeability.
- The zero turning radius and the light weight make this machine ideal for space restricted conditions, providing exceptional maneuverability.
- Exceptional waterproofed drive system design provides excellent performance in wet conditions.
- Commonality of control system with other electric scissor lifts.

MODELS	SS0407E (SS1230E)		SS0507E(SS1432E)		SS0607E(SS1932E)	
Measurements	Metric	US	Metric	US	Metric	US
Working Height Max.	5.6m	18.4ft	6.3m	20.7ft	7.5m	24.6ft
A Platform Height-Raised	3.6m	11.8ft	4.3m	14.1ft	5.5m	18ft
B Platform Height-Stowed	0.95m	3.1ft	1.04m	3.4ft	1.17m	3.8ft
C Platform Length	1.35m	4.4ft	1.35m	4.4ft	1.35m	4.4ft
D Platform Width	0.7m	2.3ft	0.7m	2.3ft	0.7m	2.3ft
E Overall Length	1.53m	5ft	1.53m	5ft	1.53m	5ft
F Overall Width	0.76m	2.5ft	0.81m	2.65ft	0.81m	2.65ft
G Overall Height-Rails Up	2.06m	6.78ft	2.15m	7.1ft	2.28m	7.46ft
Overall Height-Rails Down	1.65m	5.41ft	1.76m	5.77ft	1.86m	6.1ft
H Extension Deck	0.6m	2ft	0.6m	2ft	0.6m	2ft
I Wheelbase	1.12m	44.1in	1.12m	44.1in	1.12m	44.1in
Ground Clearance (Stowed/Raised)	50/16mm	1.97/0.63in	50/16mm	1.97/0.63in	50/16mm	1.97/0.63in

PRODUCTIVITY

Platform Occupants Max. (in/out)	2 / 1	2 / 1	2 / 1	2 / 0	2 / 0	2 / 0
Platform Capacity	240kg	530lbs	230kg	510lbs	230kg	510lbs
Platform Capacity-Extension	113kg	265lbs	113kg	265lbs	113kg	265lbs
Drive Height	Full Height		Full Height		Full Height	
Gradeability-Stowed	25%		25%		25%	
Turning Radius-Outside	1.5m	4.9ft	1.5m	4.9ft	1.5m	4.9ft
Raise/Lower Speed	25 / 20s		25 / 20s		32 / 27s	
Brakes	Front-wheel Brake		Front-wheel Brake		Front-wheel Brake	
Drive Mode	4x2		4x2		4x2	
Tires Type	Solid Non-marking		Solid Non-marking		Solid Non-marking	
Tires Size	230x80mm	9.1x3.1in	230x80mm	9.1x3.1in	230x80mm	9.1x3.1in

POWER

Power Source	24V DC 115Ah		24V DC 150Ah		24V DC 150Ah	
--------------	--------------	--	--------------	--	--------------	--

HYDRAULIC SYSTEM

Hydraulic Oil Capacity	4.5 L	1gal	4.5 L	1gal	4.5 L	1gal
------------------------	-------	------	-------	------	-------	------

WEIGHT

Machine Weight(CE)	880kg	1940lbs	985kg	2172lbs	1335kg	2866lbs
--------------------	-------	---------	-------	---------	--------	---------

ELECTRIC MOTOR DRIVE SCISSOR LIFT

SS0407ER (SS1230ER) / SS0507ER (SS1432ER)

SS0607ER (SS1932ER)



HIGHLIGHTS

LGMG ER Series scissor lifts are equipped with an advanced maintenance free battery for better productivity with a lower service cost. This series is an ideal solution for the low-level access and space restricted application job sites. Shorter overall machine length and lighter weight makes it suitable for most elevators.

- Battery powered, zero emission and quiet drive mean this machine is environmentally friendly.
- Efficient electric drive system provides longer-lasting performance and better gradeability.
- Light weight and compact design provide better productivity with easier lifting on multi-level site applications.
- Exceptional waterproofed drive system provides excellent performance in wet conditions.
- Commonality of control system with other electric scissor lifts.

SPECIFICATIONS

MODELS	SS0407ER (SS1230ER)		SS0507ER (SS1432ER)		SS0607ER (SS1932ER)	
Measurements	Metric	US	Metric	US	Metric	US
Working Height Max.	5.6m	18.4ft	6.6m	21.7ft	7.6m	25ft
A Platform Height-Raised	3.6m	11.8ft	4.6m	15.1ft	5.6m	18.4ft
B Platform Height-Stowed	0.86m	2.8ft	1m	3.3ft	1.1m	3.6ft
C Platform Length	1.35m	4.4ft	1.35m	4.4ft	1.35m	4.4ft
D Platform Width	0.73m	2.3ft	0.73m	2.3ft	0.73m	2.3ft
E Overall Length	1.53m	5ft	1.53m	5ft	1.53m	5ft
F Overall Width	0.76m	2.5ft	0.81m	2.65ft	0.81m	2.65ft
G Overall Height-Rails Up	2m	6.56ft	2.1m	6.87ft	2.2m	7.2ft
Overall Height-Rails Down	1.57m	5.15ft	1.66m	5.45ft	1.76m	5.77ft
H Extension Deck	0.6m	2ft	0.6m	2ft	0.6m	2ft
I Wheelbase	1.12m	44.1in	1.12m	44.1in	1.12m	44.1in
Ground Clearance (Stowed/Raised)	65/17mm	2.56/0.67in	65/17mm	2.56/0.67in	65/17mm	2.56/0.67in
PRODUCTIVITY						
Platform Occupants Max. (in/out)	2 / 1	2 / 1	2 / 0	2 / 0	2 / 0	2 / 0
Platform Capacity	240kg	530lbs	230kg	510lbs	230kg	510lbs
Platform Capacity-Extension	120kg	265lbs	120kg	265lbs	120kg	265lbs
Drive Height	Full Height		Full Height		Full Height	
Gradeability-Stowed	25%		25%		25%	
Turning Radius-Outside	1.46m	4.79ft	1.49m	4.89ft	1.49m	4.89ft
Raise/Lower Speed	25 / 18s		25 / 20s		32 / 27s	
Brakes	Rear-wheel Brake		Rear-wheel Brake		Rear-wheel Brake	
Drive Mode	4x2		4x2		4x2	
Tires Type	Solid Non-marking		Solid Non-marking		Solid Non-marking	
Tires Size	250x80mm	9.8x3.1in	250x80mm	9.8x3.1in	250x80mm	9.8x3.1in
POWER						
Power Source	24V DC 115Ah		24V DC 150Ah		24V DC 150Ah	
HYDRAULIC SYSTEM						
Hydraulic Oil Capacity	3.5 L	0.8gal	3.5 L	0.8gal	3.5 L	0.8gal
WEIGHT						
Machine Weight(CE)	885kg	1951lbs	1040kg	2293lbs	1300kg	2866lbs

ELECTRIC MOTOR DRIVE SCISSOR LIFT

AS0607E (AS1930E) / AS0607WE (AS1932E)

AS0608E (AS2032E) / AS0808E (AS1932E)

SPECIFICATIONS



HIGHLIGHTS

LGMG E Series scissor lifts provide longer battery duty cycle life with a direct electric drive system. This series can be used on a variety of construction sites, maintenance job sites and other applications, both indoor and outdoor. The wide product line from 3.6m to 13.8m platform height are perfect for different working height requirements.

- Battery powered, zero emission and quiet drive mean this machine is environmentally friendly.
- Efficient electric drive system provides longer-lasting performance and better gradeability.
- Proportional lift and drive controls deliver smoother operation.
- Swing out component trays for easy access and maintenance.
- Intelligent self-diagnostic system for quick troubleshooting.
- Commonality in parts with other electric scissor lifts.

MODELS	AS0607E (AS1930E)		AS0607WE (AS1932E)		AS0608E (AS2032E)		AS0808E (AS2632E)	
Measurements	Metric	US	Metric	US	Metric	US	Metric	US
Working Height Max.	7.8m	25.6ft	7.8m	25.6ft	7.9m	25.9ft	10m	32.8ft
A Platform Height-Raised	5.8m	19ft	5.8m	19ft	5.9m	19.4ft	8m	26.2ft
B Platform Height-Stowed	1.02m	3.3ft	1.02m	3.3ft	1.03m	3.4ft	1.14m	3.7ft
C Platform Length	1.63m	5.3ft	1.63m	5.3ft	2.26m	7.4ft	2.26m	7.4ft
D Platform Width	0.73m	2.4ft	0.73m	2.4ft	0.81m	2.7ft	0.81m	2.7ft
E Overall Length	1.86m	6.1ft	1.86m	6.1ft	2.4m	7.9ft	2.4m	7.9ft
F Overall Width	0.76m	2.5ft	0.81m	2.7ft	0.83m	2.7ft	0.83m	2.7ft
G Overall Height-Rails Up	2.14m	7ft	2.14m	7ft	2.19m	7.2ft	2.32m	7.61ft
Overall Height-Rails Down	1.84m	6ft	1.84m	6ft	1.83m	6ft	1.95m	6.4ft
H Extension Deck	0.9m	3ft	0.9m	3ft	0.9m	3ft	0.9m	3ft
I Wheelbase	1.35m	53in	1.35m	53in	1.85m	73in	1.85m	73in
Ground Clearance (Stowed/Raised)	80/20mm	3.15/0.79in	80/20mm	3.15/0.79in	100/25mm	3.94/0.98in	100/25mm	3.94/0.98in

PRODUCTIVITY

Platform Occupants Max. (in/out)	2 / 0	2 / 0	2 / 1	2 / 1	2 / 1	2 / 1	2 / 0	2 / 0
Platform Capacity	230kg	510lbs	230kg	510lbs	380kg	838lbs	230kg	510lbs
Platform Capacity-Extension	120kg	265lbs	120kg	265lbs	113kg	265lbs	120kg	265lbs
Drive Height	Full Height		Full Height		Full Height		Full Height	
Gradeability-Stowed	25%		25%		25%		25%	
Turning Radius-Outside	1.72m	5.6ft	1.75m	5.6ft	2.15m	7ft	2.15m	7ft
Raise/Lower Speed	16 / 28s		16 / 28s		30 / 34s		31 / 40s	
Brakes	Front-wheel Brake		Front-wheel Brake		Front-wheel Brake		Front-wheel Brake	
Drive Mode	4x2		4x2		4x2		4x2	
Tires Type	Solid Non-marking		Solid Non-marking		Solid Non-marking		Solid Non-marking	
Tires Size	323x100mm	12.7x4in	323x100mm	12.7x4in	380x130mm	15x5in	380x130mm	15x5in

POWER

Power Source	24V DC 225Ah	24V DC 225Ah	24V DC 225Ah	24V DC 225Ah
--------------	--------------	--------------	--------------	--------------

HYDRAULIC SYSTEM

Hydraulic Oil Capacity	9.5 L	2.1gal	9.5 L	2.1gal	13 L	3.4gal	13 L	3.4gal
------------------------	-------	--------	-------	--------	------	--------	------	--------

WEIGHT

Machine Weight(CE)	1610kg	3549lbs	1620kg	3571lbs	2000kg	4409lbs	2140kg	4718lbs
--------------------	--------	---------	--------	---------	--------	---------	--------	---------

ELECTRIC MOTOR DRIVE SCISSOR LIFT

AS0812E (AS2646E) / AS1012E (AS3246E)

AS1212E (AS4046E)

SPECIFICATIONS



HIGHLIGHTS

LGMG E Series scissor lifts provide longer battery duty cycle life with its direct electric drive system. This range can be applied to various construction sites, maintenance job sites and other applications both indoor and outdoor. The wide range product line from 3.6m to 13.8m platform height can satisfy a range of different working height requirements.

- Battery powered, zero emission and quiet drive mean this machine is environmentally friendly.
- Efficient electric drive system provides longer-lasting performance and better gradeability.
- Proportional lift and drive controls deliver smoother operation.
- Swing out component trays for easy access and maintenance.
- Intelligent self-diagnostic system for quick troubleshooting.
- Commonality in parts with other electric scissor lifts.

MODELS	AS0812E (AS2646E)		AS1012E (AS3246E)		AS1212E (AS4046E)	
Measurements	Metric	US	Metric	US	Metric	US
Working Height Max.	10m	32.8ft	12m	39.4ft	14m	46ft
A Platform Height-Raised	8m	26.2ft	10m	32.8ft	12m	39.4ft
B Platform Height-Stowed	1m	3.4ft	1.2m	3.9ft	1.3m	4.3ft
C Platform Length	2.26m	7.4ft	2.26m	7.4ft	2.26m	7.4ft
D Platform Width	1.15m	3.8ft	1.15m	3.8ft	1.15m	3.8ft
E Overall Length	2.42m	8ft	2.47m	8.1ft	2.47m	8.1ft
F Overall Width	1.18m	3.87ft	1.18m	3.87ft	1.18m	3.87ft
G Overall Height-Rails Up	2.3m	7.55ft	2.43m	7.97ft	2.56m	8.4ft
Overall Height-Rails Down	1.73m	5.7ft	1.86m	6.1ft	1.99m	6.5ft
H Extension Deck	0.9m	3ft	0.9m	3ft	0.9m	3ft
I Wheelbase	1.85m	73in	1.85m	73in	1.85m	73in
Ground Clearance (Stowed/Raised)	100/20mm	3.94/0.79in	100/20mm	3.94/0.79in	100/20mm	3.94/0.79in

PRODUCTIVITY

Platform Occupants Max. (in/out)	2 / 1	2 / 1	2 / 1	2 / 1	2 / 0	2 / 0
Platform Capacity	450kg	990lbs	320kg	705lbs	320kg	705lbs
Platform Capacity-Extension	113kg	265lbs	113kg	265lbs	113kg	265lbs
Drive Height	Full Height		Full Height		Full Height	
Gradeability-Stowed	25%		25%		25%	
Turning Radius-Outside	2.3m	7.5ft	2.3m	7.5ft	2.3m	7.5ft
Raise/Lower Speed	35 / 40s		58 / 48s		58 / 60s	
Brakes	Front-wheel Brake		Front-wheel Brake		Front-wheel Brake	
Drive Mode	4x2		4x2		4x2	
Tires Type	Solid Non-marking		Solid Non-marking		Solid Non-marking	
Tires Size	380x130mm	15x5in	380x130mm	15x5in	380x130mm	15x5in

POWER

Power Source	24V DC 240Ah		24V DC 240Ah		24V DC 300Ah	
--------------	--------------	--	--------------	--	--------------	--

HYDRAULIC SYSTEM

Hydraulic Oil Capacity	16 L	4.2gal	23 L	6.1gal	23 L	6.1gal
------------------------	------	--------	------	--------	------	--------

WEIGHT

Machine Weight (CE/ANSI)	2360kg	5357lbs	3000kg	6614lbs	3160kg	6967lbs
--------------------------	--------	---------	--------	---------	--------	---------

ELECTRIC SCISSOR LIFT

AS1413E (AS4650E)

SPECIFICATIONS



HIGHLIGHTS

With a platform height of 13.8m, The LGMG AS1413E greatly expands the working height of electric scissor lifts and improves the productivity for the operators in high applications.

- Efficient AC motor drive system provides longer lasting performance and better gradeability.
- 320kg capacity with 0.9m extension deck offers great productivity.
- Battery powered, zero emission and quiet drive mean this machine is environmentally friendly.
- Forklift pockets on both side and rear position for easy handling.
- Swing out component trays for easy access and maintenance.
- Intelligent self-diagnostic system for quick troubleshooting.

MODELS	AS1413E (AS4650E)	
Measurements	Metric	US
Working Height Max.(Indoor/Outdoor)	15.8 / 10m	51.8 / 32.8ft
A Platform Height-Raised(Indoor/Outdoor)	13.8 / 8m	45.3 / 26.2ft
B Platform Height-Stowed	1.57m	5.2ft
C Platform Length	2.64m	8.7ft
D Platform Width	1.12m	3.67ft
E Overall Length	2.8m	9.2ft
F Overall Width	1.3m	4.3ft
G Overall Height-Rails Up	2.74m	9ft
Overall Height-Rails Down	1.94m	6.4ft
H Extension Deck	0.9m	3ft
I Wheelbase	2.22m	87.4in
Ground Clearance (Stowed/Raised)	105/20mm	4.1/0.79in
PRODUCTIVITY		
Platform Occupants Max. (in/out)	2 / 1	2 / 1
Platform Capacity	320kg	705lbs
Platform Capacity-Extension	113kg	265lbs
Drive Height	Full Height	
Gradeability-Stowed	25%	
Turning Radius-Outside	2.85m	9.35ft
Raise/Lower Speed	85 / 65s	
Brakes	Front-wheel Brake	
Drive Mode	4x2	
Tires Type	Solid Non-marking	
Tires Size	380x130mm	15x5in
POWER		
Power Source	24V DC 300Ah	
HYDRAULIC SYSTEM		
Hydraulic Oil Capacity	25.5 L	6.7gal
WEIGHT		
Machine Weight (CE/ANSI)	3500kg	7716lbs

HYDRAULIC MOTOR DRIVE SCISSOR LIFT

AS0607 (AS1930) / AS0607W (AS1932)

AS0608 (AS2032) / AS0808 (AS2632)

SPECIFICATIONS



HIGHLIGHTS

LGMG hydraulic motor drive scissor lifts offer industry leading reliability and simple design. They can be applied to various construction sites, maintenance job sites and other applications, both indoor and outdoor. The wide range product line from 5.8m to 13.8m platform height make these machines suitable for a wide range of requirements.

- Upgraded and reinforced design delivers better performance for various harsh conditions.
- The simple and reliable hydraulic system offers better productivity.
- Swing out component trays for easy access and maintenance.
- CAN bus system and intelligent self-diagnostic system for quick troubleshooting.
- Commonality in key parts with other scissor lifts.

MODELS	AS0607 (AS1930)		AS0607W (AS1932)		AS0608 (AS2032)		AS0808 (AS2632)	
Measurements	Metric	US	Metric	US	Metric	US	Metric	US
Working Height Max.	7.8m	25.6ft	7.8m	25.6ft	7.9m	25.9ft	10m	32.8ft
A Platform Height-Raised	5.8m	19ft	5.8m	19ft	5.9m	19.4ft	8m	26.2ft
B Platform Height-Stowed	1.02m	3.3ft	1.02m	3.3ft	1.03m	3.4ft	1.14m	3.7ft
C Platform Length	1.63m	5.3ft	1.63m	5.3ft	2.26m	7.4ft	2.26m	7.4ft
D Platform Width	0.73m	2.4ft	0.73m	2.4ft	0.81m	2.7ft	0.81m	2.7ft
E Overall Length	1.83m	6ft	1.83m	6ft	2.4m	7.9ft	2.4m	7.9ft
F Overall Width	0.76m	2.5ft	0.81m	2.7ft	0.83m	2.7ft	0.83m	2.7ft
G Overall Height-Rails Up	2.12m	7ft	2.12m	7ft	2.19m	7.2ft	2.32m	7.6ft
Overall Height-Rails Down	1.82m	6ft	1.82m	6ft	1.83m	6ft	1.95m	6.4ft
H Extension Deck	0.9m	3ft	0.9m	3ft	0.9m	3ft	0.9m	3ft
I Wheelbase	1.32m	52in	1.32m	52in	1.85m	73in	1.85m	73in
Ground Clearance (Stowed/Raised)	60/20mm	2.36/0.79in	60/20mm	2.36/0.79in	100/25mm	3.94/0.98in	100/25mm	3.94/0.98in

PRODUCTIVITY

Platform Occupants Max. (in/out)	2 / 0	2 / 0	2 / 1	2 / 1	2 / 1	2 / 1	2 / 0	2 / 0
Platform Capacity	230kg	510lbs	230kg	510lbs	380kg	838lbs	230kg	510lbs
Platform Capacity-Extension	120kg	265lbs	120kg	265lbs	113kg	265lbs	120kg	265lbs
Drive Height	Full Height		Full Height		Full Height		Full Height	
Gradeability-Stowed	25%		25%		25%		25%	
Turning Radius-Outside	1.65m	5.4ft	1.65m	5.4ft	2.15m	7ft	2.15m	7ft
Raise/Lower Speed	16 / 28s		16 / 28s		30 / 34s		31 / 40s	
Brakes	Rear-wheel Brake		Rear-wheel Brake		Rear-wheel Brake		Rear-wheel Brake	
Drive Mode	4x2		4x2		4x2		4x2	
Tires Type	Solid Non-marking		Solid Non-marking		Solid Non-marking		Solid Non-marking	
Tires Size	305x114mm	12x4.5in	305x114mm	12.7x4.5in	380x130mm	15x5in	380x130mm	15x5in

POWER

Power Source	24V DC 225Ah	24V DC 225Ah	24V DC 225Ah	24V DC 225Ah
--------------	--------------	--------------	--------------	--------------

HYDRAULIC SYSTEM

Hydraulic Oil Capacity	9.5 L	2.1gal	9.5 L	2.1gal	13 L	3.4gal	13 L	3.4gal
------------------------	-------	--------	-------	--------	------	--------	------	--------

WEIGHT

Machine Weight(CE)	1580kg	3483lbs	1600kg	3527lbs	2000kg	4409lbs	2140kg	4718lbs
--------------------	--------	---------	--------	---------	--------	---------	--------	---------

ELECTRIC MOTOR DRIVE SCISSOR LIFT

AS0812 (AS2646) / AS1012 (AS3246)

AS1212 (AS4046) / AS1413 (AS4650)

SPECIFICATIONS



HIGHLIGHTS

LGMG hydraulic motor drive scissor lifts offer industry leading reliability and simple design. They can be applied to various construction sites, maintenance job sites and other applications, both indoor and outdoor. The wide range product line from 5.8m to 13.8m platform height make these machines suitable for a wide range of requirements.

- Upgraded and reinforced design delivers better performance for various harsh conditions.
- The simple and reliable hydraulic system offers better productivity.
- Swing out component trays for easy access and maintenance.
- CAN bus system and intelligent self-diagnostic system for quick troubleshooting.
- Commonality in key parts with other scissor lifts.

MODELS	AS0812 (AS2646)		AS1012 (AS3246)		AS1212 (AS4046)		AS1413 (AS4650)	
Measurements	Metric	US	Metric	US	Metric	US	Metric	US
Working Height Max.	10m	32.8ft	12m	39.4ft	14m	46ft	15.8/10m	51.8/32.8ft
A Platform Height-Raised	8m	26.2ft	10m	32.8ft	12m	39.4ft	13.8/8m	45.3/26.2ft
B Platform Height-Stowed	1m	3.4ft	1.2m	3.9ft	1.3m	4.3ft	1.6m	5.25ft
C Platform Length	2.26m	7.4ft	2.26m	7.4ft	2.26m	7.4ft	2.64m	8.7ft
D Platform Width	1.15m	3.8ft	1.15m	3.8ft	1.15m	3.8ft	1.12m	3.8ft
E Overall Length	2.42m	8ft	2.47m	8ft	2.47m	8ft	2.8m	9.2ft
F Overall Width	1.18m	3.9ft	1.18m	3.9ft	1.18m	3.9ft	1.3m	4.3ft
G Overall Height-Rails Up	2.3m	7.55ft	2.43m	7.97ft	2.59m	8.4ft	2.74m	9ft
Overall Height-Rails Down	1.73m	5.7ft	1.86m	6.1ft	1.99m	6.5ft	1.94m	7.1ft
H Extension Deck	0.9m	3ft	0.9m	3ft	0.9m	3ft	0.9m	3ft
I Wheelbase	1.85m	73in	1.85m	73in	1.85m	73in	2.22m	87.4in
Ground Clearance (Stowed/Raised)	100/20mm	3.94/0.79in	100/20mm	3.94/0.79in	100/20mm	3.94/0.79in	105/20mm	4.1/0.79in

PRODUCTIVITY

Platform Occupants Max. (in/out)	2 / 1	2 / 1	2 / 1	2 / 1	2 / 0	2 / 0	2 / 1	2 / 1
Platform Capacity	450kg	990lbs	320kg	705lbs	320kg	750lbs	320kg	705lbs
Platform Capacity-Extension	113kg	265lbs	113kg	265lbs	113kg	265lbs	113kg	265lbs
Drive Height	Full Height		Full Height		Full Height		Full Height	
Gradeability-Stowed	25%		25%		25%		25%	
Turning Radius-Outside	2.3m	7.5ft	2.3m	7.5ft	2.3m	7.5ft	2.85m	9.4ft
Raise/Lower Speed	35 / 40s		58 / 48s		65 / 60s		80 / 65s	
Brakes	Rear-wheel Brake		Rear-wheel Brake		Rear-wheel Brake		Rear-wheel Brake	
Drive Mode	4x2		4x2		4x2		4x2	
Tires Type	Solid Non-marking		Solid Non-marking		Solid Non-marking		Solid Non-marking	
Tires Size	380x130mm	15x5in	380x130mm	15x5in	380x130mm	15x5in	380x130mm	15x5in

POWER

Power Source	24V DC 240Ah	24V DC 240Ah	24V DC 300Ah	24V DC 300Ah
--------------	--------------	--------------	--------------	--------------

HYDRAULIC SYSTEM

Hydraulic Oil Capacity	16 L	4.2gal	23 L	6.1gal	23 L	6.1gal	25.5 L	6.7gal
------------------------	------	--------	------	--------	------	--------	--------	--------

WEIGHT

Machine Weight(CE)	2360kg	5357lbs	3000kg	6614lbs	3160kg	6967lbs	3500kg	7716lbs
--------------------	--------	---------	--------	---------	--------	---------	--------	---------

ELECTRIC RT SCISSOR LIFT

SR0818E (SR2669E) **NEW PRODUCT**

SR1018E (SR3369E) / SR1218E (SR4069E)



HIGHLIGHTS

LGMG SR18E Series rough terrain scissor lifts deliver a large platform, high capacity and environmentally friendly solutions for both indoor and outdoor applications. A compact design, battery powered together with oscillating axles provides flexibility for the machine to work on both firm level and rough terrain environments.

- High capacity, large platform with compact design maximizes productivity.
- Battery powered, zero emission and quiet drive mean this machine is environmentally friendly.
- Equipped with oscillating axles that provide excellent performance in soft and rough terrain conditions.
- Optional hydraulic outriggers deliver a better solution on uneven ground.
- Intelligent self-diagnostic system for quick troubleshooting.

SPECIFICATIONS

MODELS	NEW SR0818E (SR2669E)		SR1018E (SR3369E)		SR1218E(SR4069E)	
Measurements	Metric	US	Metric	US	Metric	US
Working Height Max.	9.7m	31.8ft	11.7m	38.4ft	13.9m	45.9ft
A Platform Height-Raised	7.7m	25.26ft	9.7m	31.8ft	11.9m	39ft
B Platform Height-Stowed	1.41m	4.62ft	1.41m	4.62ft	1.56m	5.12ft
C Platform Length	2.79m	9.15ft	2.79m	9.15ft	2.79m	9.15ft
D Platform Width	1.6m	5.25ft	1.6m	5.25ft	1.6m	5.25ft
E Overall Length	3.11m	10.2ft	3.76m	12.33ft	3.76m	12.33ft
F Overall Width	1.79m	5.87ft	1.79m	5.87ft	1.79m	5.87ft
G Overall Height-Rails Up	2.58m	8.46ft	2.55m	8.37ft	2.7m	8.86ft
Overall Height-Rails Down	1.89m	6.2ft	1.89m	6.2ft	2.04m	6.69ft
H Extension Deck	1.52m	4.99ft	1.52m	4.99ft	1.52m	4.99ft
I Wheelbase	2.29m	75.1in	2.29m	75.1in	2.29m	75.1in
Ground Clearance-Center	0.23m	0.75ft	0.23m	0.75ft	0.23m	0.75ft

PRODUCTIVITY

Platform Occupants Max. (in/out)	4 / 4	4 / 4	4 / 2	4 / 2	3 / 2	3 / 2
Platform Capacity	680kg	1499lbs	454kg	1000lbs	365kg	805lbs
Platform Capacity-Extension	140kg	310lbs	140kg	310lbs	140kg	310lbs
Drive Height	Full Height		Full Height		Full Height	
Gradeability-Stowed	40%		35%		35%	
Turning Radius-Outside	4.75m	15.6ft	4.75m	15.6ft	4.75m	15.6ft
Raise/Lower Speed	35 / 30s		39 / 46s		61 / 55s	
Brakes	Rear-wheel Brake		Rear-wheel Brake		Rear-wheel Brake	
Drive Mode	4x2		4x2		4x2	
Tires Type	Foam-filled Non-marking		Foam-filled Non-marking		Foam-filled Non-marking	
Tires Size	663x283mm	26x12in	663x283mm	26x12in	663x283mm	26x12in

POWER

Power Source	48V DC 315Ah		48V DC 315Ah		48V DC 315Ah	
Fuel Tank Capacity	/		/		/	

HYDRAULIC SYSTEM

Hydraulic Oil Capacity	50 L	13.21gal	70 L	18.5gal	70 L	18.5gal
------------------------	------	----------	------	---------	------	---------

WEIGHT

Machine Weight with Outriggers(CE/ANSI)	4074kg	8981lbs	4350kg	9570lbs	5100kg	11245lbs
Machine Weight without Outriggers(Optional)	3720kg	8201lbs	/	/	/	/

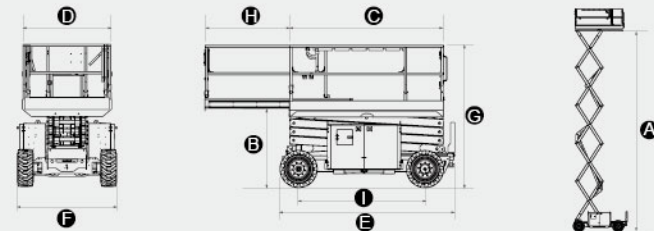

DIESEL RT SCISSOR Lift

SR0818D (SR2669D) **NEW PRODUCT**

SR1018D (SR3369D) / SR1218D (SR4069D)

SPECIFICATIONS



HIGHLIGHTS

LGMG SR18D Series rough terrain scissor lifts are specifically built for tough construction sites with four-wheel drive and fantastic gradeability. High load capacities with compact design provide a great combination for the larger working area and greater maneuverability through rough terrain job sites.

- High capacity, large platform with compact design maximises productivity.
- Powerful diesel engine and four-wheel drive make the machine ideal for varying conditions.
- Oscillating axles with great gradeability provide better performance on rough terrain job sites.
- Optional hydraulic outriggers deliver better stability on uneven ground.
- Intelligent self-diagnostic system for quick troubleshooting.

MODELS	NEW SR0818D (SR2669D)		SR1018D (SR3369D)		SR1218D(SR4069D)	
Measurements	Metric	US	Metric	US	Metric	US
Working Height Max.	9.7m	31.8ft	11.7m	38.4ft	13.9m	45.9ft
A Platform Height-Raised	7.7m	25.26ft	9.7m	31.8ft	11.9m	39ft
B Platform Height-Stowed	1.41m	4.62ft	1.41m	4.62ft	1.56m	5.12ft
C Platform Length	2.79m	9.15ft	2.79m	9.15ft	2.79m	9.15ft
D Platform Width	1.6m	5.25ft	1.6m	5.25ft	1.6m	5.25ft
E Overall Length	3.11m	10.2ft	3.76m	12.33ft	3.76m	12.33ft
F Overall Width	1.79m	5.87ft	1.79m	5.87ft	1.79m	5.87ft
G Overall Height-Rails Up	2.58m	8.46ft	2.55m	8.37ft	2.7m	8.86ft
Overall Height-Rails Down	1.89m	6.2ft	1.89m	6.2ft	2.04m	6.69ft
H Extension Deck	1.52m	4.99ft	1.52m	4.99ft	1.52m	4.99ft
I Wheelbase	2.29m	75.1in	2.29m	75.1in	2.29m	75.1in
Ground Clearance-Center	0.23m	0.75ft	0.23m	0.75ft	0.23m	0.75ft

PRODUCTIVITY

Platform Occupants Max. (in/out)	4 / 4	4 / 4	4 / 2	4 / 2	3 / 2	3 / 2
Platform Capacity	680kg	1499lbs	454kg	1000lbs	365kg	805lbs
Platform Capacity-Extension	140kg	310lbs	140kg	310lbs	140kg	310lbs
Drive Height	Full Height		Full Height		Full Height	
Gradeability-Stowed	40%		35%		35%	
Turning Radius-Outside	4.75m	15.6ft	4.75m	15.6ft	4.75m	15.6ft
Raise/Lower Speed	35 / 30s		39 / 46s		61 / 55s	
Brakes	Four-wheel Brake		Four-wheel Brake		Four-wheel Brake	
Drive Mode	4x4		4x4		4x4	
Tires Type	Foam-filled		Foam-filled		Foam-filled	
Tires Size	663x283mm	26x12in	663x283mm	26x12in	663x283mm	26x12in

POWER

Power Source	Kubota D1105 18.5kw/24.8hp	Kubota D1105 18.5kw/24.8hp	Kubota D1105 18.5kw/24.8hp			
Fuel Tank Capacity	53 L	14gal	53 L	14gal	53 L	14gal

HYDRAULIC SYSTEM

Hydraulic Oil Capacity	50 L	13.21gal	70 L	18.5gal	70 L	18.5gal
------------------------	------	----------	------	---------	------	---------

WEIGHT

Machine Weight with Outriggers(CE/ANSI)	4054kg	8937lbs	4330kg	9768lbs	5080kg	11176lbs
Machine Weight without Outriggers(Optional)	3700kg	8157lbs	/	/	/	/

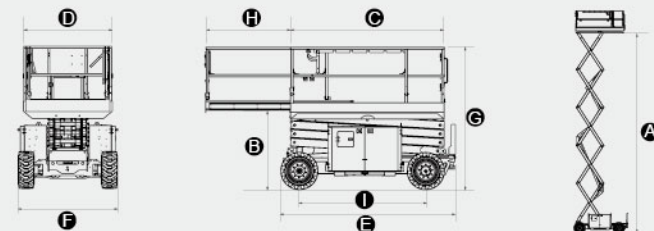

DIESEL RT SCISSOR Lift

SR1023D (SR3390D) / SR1323D (SR4390D)
SR1623D (SR5390D)

SPECIFICATIONS



HIGHLIGHTS

LGMG SR23D Series rough terrain scissor lifts deliver higher capacities and larger platforms for the most tough construction job sites. Four-wheel drive, oscillating axels and hydraulic outriggers provide superior stability on the most tough uneven surfaces.

- Larger working platform with dual extension decks offers great productivity.
- Powerful diesel engine, oscillating axels and four-wheel drive provide better performance on most rough terrain job sites.
- Standard features with one button auto leveling outriggers, overload system, motion alarm, help the operator to complete the job in a much safer way.
- Pull-out engine tray for easy access and maintenance.
- On-board self-diagnosis system makes it easier for quick troubleshooting.

MODELS	SR1023D (SR3390D)		SR1323D (SR4390D)		SR1623D(SR5390D)	
Measurements	Metric	US	Metric	US	Metric	US
Working Height Max.	12m	39.4ft	15m	49.2ft	17.9m	58.7ft
A Platform Height-Raised	10m	32.8ft	13m	42.65ft	15.9m	52.2ft
B Platform Height-Stowed	1.58m	62ft	1.83m	72ft	2.08m	81.9ft
C Platform Length	3.98m	13ft	3.98m	13ft	3.98m	13ft
D Platform Width	1.83m	6ft	1.83m	6ft	1.83m	6ft
E Overall Length	4.9m	16.1	4.9m	16.1ft	4.9m	16.1ft
F Overall Width	2.3m	7.55ft	2.3m	7.55ft	2.3m	7.55ft
G Overall Height-Rails Up	2.74m	8.99ft	2.96m	9.71ft	3.18m	10.45ft
Overall Height-Rails Down	2.06m	6.75ft	2.28m	7.48ft	2.5m	8.2ft
Extension Deck	1.45/1.14m	4.76/3.74ft	1.45/1.14m	4.76/3.74ft	1.45/1.14m	4.76/3.74ft
H Wheelbase	2.85m	112.2in	2.85m	112.2in	2.85m	112.2in
Ground Clearance-Center	0.23m	0.75ft	0.23m	0.75ft	0.23m	0.75ft

PRODUCTIVITY

Platform Occupants Max. (in/out)	7 / 7	7 / 7	7 / 7	7 / 7	4 / 4	4 / 4
Platform Capacity	1100kg	2425lbs	910kg	2005lbs	680kg	1500lbs
Platform Capacity-Extension	230kg	510lbs	230kg	510lbs	230kg	510lbs
Drive Height	10m	32.8ft	8.5m	27.9ft	8.5m	27.9ft
Gradeability-Stowed	40%		40%		40%	
Turning Radius-Outside	5.33m	17.45ft	5.33m	17.45ft	5.33m	17.45ft
Raise/Lower Speed	45 / 45s		55 / 55s		55 / 55s	
Brakes	Four-wheel Brake		Four-wheel Brake		Four-wheel Brake	
Drive Mode	4x4		4x4		4x4	
Tires Type	Solid		Solid		Solid	
Tires Size	835x290mm	33x12in	835x290mm	33x12in	835x290mm	33x12in

POWER

Power Source	Deutz D2.9 L4 36.4kw/48.8hp		Deutz D2.9 L4 36.4kw/48.8hp		Deutz D2.9 L4 36.4kw/48.8hp	
Fuel Tank Capacity	110 L	30gal	110 L	30gal	110 L	30gal

HYDRAULIC SYSTEM

Hydraulic Oil Capacity	140 L	37gal	140 L	37gal	140 L	37gal
------------------------	-------	-------	-------	-------	-------	-------

WEIGHT

Machine Weight(6.58m platform,CE/ANSI)	6880kg	15170lbs	7360kg	16230lbs	8100kg	17860lbs
Machine Weight(7.4m platform,CE/ANSI)	6980kg	15400lbs	7460kg	16450lbs	8200kg	18080lbs

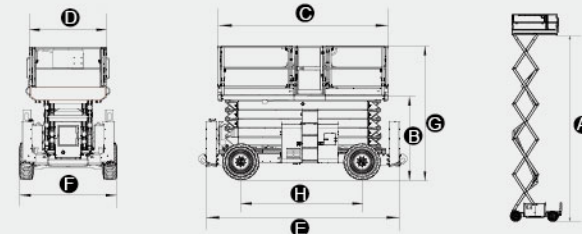

ARTICULATING/ TELESCOPIC BOOM LIFT

ELECTRIC ARTICULATING BOOM LIFT



LGMG A14JE electric articulating boom lifts provide environmentally friendly, zero emission operation for both indoor and outdoor applications. Up to 13.8m platform height with 1.5m standard jib, A14JE offers great ability to extend over obstacles in tight working areas.

DIESEL ARTICULATING BOOM LIFT



LGMG AR Series articulating boom lifts are purpose built for outdoor construction and industrial applications. Simple and reliable design with industrial features make this machine easy to operate friendly and easy. A standard job offers the ability to reach even the most hard to reach places.

DIESEL TELESCOPIC BOOM LIFT



LGMG T Series telescopic boom lifts offer great out-reach with high working efficiency. Its exceptional all terrain capacities allow the machine to operate on the roughest ground and complete the tasks on time.

ARTICULATING BOOM LIFT

A14JE(A45JE)



HIGHLIGHTS

- Zero tail swing and compact design enables easy access to tight spaces.
- Proportional control ensures smooth driving, precise positioning and comfortable operation.
- Battery powered and sealed AC drive motor provides quiet and long battery duty cycle.
- Self-leveling platform together with hydraulic platform rotation deliver exceptional productivity.
- Intelligent self-diagnostic system for quick troubleshooting.

SPECIFICATIONS

MODELS	A14JE (A45JE)	
Measurements	Metric	US
Working Height Max.	15.8m	51.8ft
Platform Height	13.8m	45.3ft
Horizontal Outreach	7.81m	25.6ft
Up and Over Height	7.26m	23.8ft
A Stowed Length	6.66m	262in
B Stowed Width	1.8m	71in
C Stowed Height	1.98m	78in
D Platform Length	1.83m	72in
E Platform Width	0.76m	30in
Platform Capacity	230kg	510lbs
Wheelbase	2.03m	80in
Ground Clearance	0.24m	9.4in
PRODUCTIVITY		
Platform Occupants Max. (In/out)	2 / 2	2 / 2
Drive Speed-Stowed	4.8km/h	3mph
Drive Speed-Raised	1km/h	0.62mph
Gradeability-Stowed	30%	30%
Platform Rotator	160°	160°
Turnable Rotation	355°	355°
Turnable Tailswing	0	0
Turning Radius-Inside	1.83m	6ft
Turning Radius-Outside	4.10m	13.5ft
Tires Type	Foam-filled non marking	
Tires Size	719x246mm	28.3x9.7in
POWER		
Power Source	48V DC 390Ah	
Fuel Tank Capacity	/	
HYDRAULIC SYSTEM		
Hydraulic Oil Capacity	30 L	7.9gal
WEIGHT		
Machine Weight (CE/ANSI)	7500kg	16535lbs

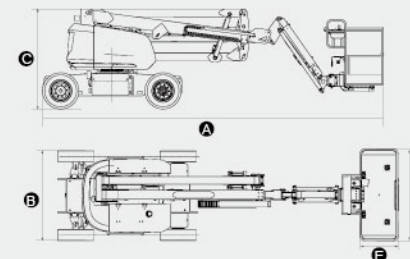

ARTICULATING BOOM LIFT

AR14J(AR45J) / AR16J(AR52J)



HIGHLIGHTS

- Oscillating axles and four-wheel drive delivers better gradeability on rough terrain.
- Proportional smooth driving, precise positioning and comfortable operation.
- Self-leveling platform together with hydraulic platform rotation deliver exceptional productivity.
- Swing out engine tray for easy access and maintenance.
- Intelligent self-diagnostic system for quick troubleshooting.

SPECIFICATIONS

MODELS	AR14J (AR45J)		AR16J (AR52J)	
Measurements	Metric	US	Metric	US
Working Height Max.	16.09m	52.79ft	17.70m	58.1ft
Platform Height	14.09m	46.23ft	15.7m	51.5ft
Horizontal Outreach	7.67m	25.16ft	9.39m	30.8ft
Up and Over Height	7.56m	24.8ft	7.56m	24.8ft
A Stowed Length	6.766m	266in	7.56m	298in
B Stowed Width	2.31m	91in	2.31m	91in
C Stowed Height	2.17m	85.4in	2.17m	85.4in
D Platform Length	1.83m	72in	1.83m	72in
E Platform Width	0.76m	30in	0.76m	30in
Platform Capacity	230kg	510lbs	230kg	510lbs
Wheelbase	2.1m	81in	2.1m	81in
Ground Clearance	0.36m	14.2in	0.36m	14.2in
PRODUCTIVITY				
Platform Occupants Max. (In/out)	2 / 2	2 / 2	2 / 2	2 / 2
Drive Speed-Stowed	6.1km/h	3.8mph	6.1km/h	3.8mph
Drive Speed-Raised	0.8km/h	0.5mph	0.8km/h	0.5mph
Gradeability-Stowed	45%	45%	45%	45%
Platform Rotator	160°	160°	160°	160°
Turnable Rotation	355°	355°	355°	355°
Turnable Tailswing	0	0	0	0
Turning Radius-Inside	1.94m	6.36ft	1.94m	6.36ft
Turning Radius-Outside	4.41m	14.47ft	4.41m	14.47ft
Tires Type	RT Foam-filled			
Tires Size	848x315mm	33.4x12.4in	848x315mm	33.4x12.4in
POWER				
Power Source	Deutz EU V Tier 4f 36.4kw/48.8hp		Deutz EU V Tier 4f 36.4kw/48.8hp	
Fuel Tank Capacity	65 L	17.2gal	65 L	17.2gal
HYDRAULIC SYSTEM				
Hydraulic Oil Capacity	130 L	34.3gal	130 L	34.3gal
WEIGHT				
Machine Weight (CE/ANSI)	7160kg	15785lbs	8180kg	18034lbs

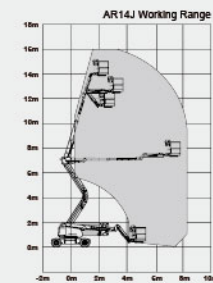
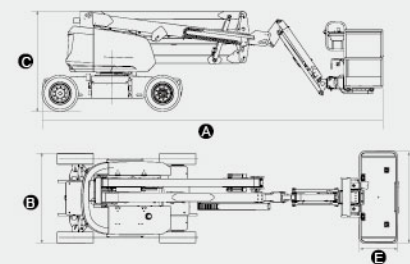

NEW PRODUCT

TELESCOPIC BOOM LIFT T22J(T72J)



HIGHLIGHTS

The T22J with the working height of 23.8m is specially developed for the market by LGMG with a larger platform and dual lift capacity. It can carry more materials in daily work and improve work efficiency.

- Dual-capacity design with 300kg(661lbs) unrestricted and 450kg(992lbs) restricted.
- 2.44×0.9m(96x35in) large platform, three-door design, more convenient for material handling.
- Four-wheel drive, 45% climbing ability, better passability and rough terrain ability.
- Continuous 360° turntable rotation expands the operational area.

A swing-out engine tray is convenient for regular maintenance and repair.

SPECIFICATIONS

MODELS	NEW T22J (T72J)	
	Metric	US
Measurements		
Working Height Max.	23.8m	78ft
Platform Height	21.8m	71.5ft
Horizontal Outreach	17.5m	57.4ft
Below Ground Reach	2.3m	90.5ft
Platform Length	2.44m	96in
Platform Width	0.9m	35in
Platform Capacity	300kg(unrestricted) 450kg(restricted)	661lbs(unrestricted) 992lbs(restricted)
A Stowed Length	10.6m	417in
B Overall Width	2.49m	98in
C Stowed Height	2.79m	110in
D Wheelbase	2.51m	99in
E Ground Clearance	0.395m	15.5in
PRODUCTIVITY		
Max. Platform Occupants	2(300kg) / 3(450kg)	2(661lbs) / 3(992lbs)
Turntable Rotation	360°continuous	360°continuous
Turntable Tailswing	1.2m	3.9ft
Drive Speed-Stowed	4.8km/h	3mph
Drive Speed-Raised	0.8km/h	0.5mph
Gradeability-Stowed	45%	45%
Max. Wind Speed	12.5m/s	28mph
Turning Radius-Inside	2.5m	8.1ft
Turning Radius-Outside	5.5m	17.8ft
Max. Slope	4.5° / 4.5°	4.5° / 4.5°
Drive Mode	4W Drive,FWS	4W Drive,FWS
Tires Type	RT Foam-filled	RT Foam-filled
Tires Size	355/55D 625	355/55D 625
POWER		
Power	Deutz D 2.9L4	Deutz D 2.9L4
Fuel Tank Capacity	100 L	26.4gal
HYDRAULIC SYSTEM		
Hydraulic Oil Capacity	180 L	47.5gal
WEIGHT		
Machine Weight (CE/ANSI)	12300kg	27117lbs

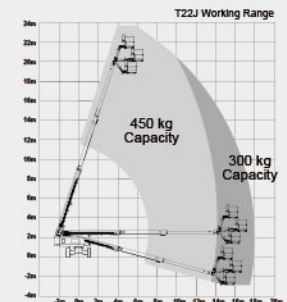
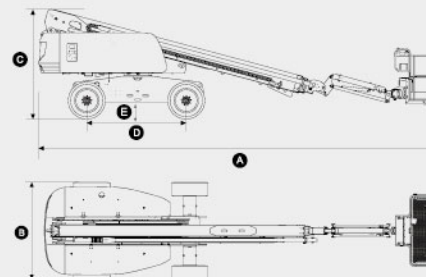

TELESCOPIC BOOM LIFT

T20J(T65J) / T26J(T85J)



HIGHLIGHTS

- Oscillating axels and four-wheel drive delivers better gradeability on rough terrain.
- Proportional control ensures smooth driving, precise positioning and comfortable operation.
- Continuous 360° rotation expands the operational area and makes operations more convenient.
- Swing out engine tray for easy access and maintenance.
- Intelligent self-diagnostic system for quick troubleshooting.

SPECIFICATIONS

MODELS	T20J (T65J)		T26J (T85J)	
Measurements	Metric	US	Metric	US
Working Height Max.	21.7m	71.2ft	27.9m	91.5ft
Platform Height	19.7m	64.6ft	25.9m	84.9ft
Horizontal Outreach	17.2m	56.4ft	23.32m	76.5ft
Below Ground Reach	2.72m	8.92ft	2.89m	9.48ft
Platform Length	2.44m	96in	2.44m	96in
Platform Width	0.90m	36in	0.90m	36in
Platform Capacity	250kg	551lbs	250 / 340kg	551 / 750lbs
A Stowed Length	9.47m	31.07ft	12.6m	41.3ft
B Overall Width	2.495m	8.186ft	2.5m	8.2ft
C Stowed Height	2.77m	9.09ft	2.84m	9.38ft
D Wheelbase	2.51m	8.24ft	2.85m	9.35ft
E Ground Clearance	0.395m	1.296ft	0.44m	1.44ft
PRODUCTIVITY				
Platform Occupants Max. (in/out)	2 / 2	2 / 2	2 / 2	2(551lbs) / 3(750lbs)
Turntable Rotation	360° continuous		360° continuous	
Turntable Tailswing	1.22m	4ft	1.42m	4.66ft
Drive Speed-Stowed	4.8km/h	3mph	4.8km/h	3mph
Drive Speed-Raised	0.8km/h	0.5mph	0.8km/h	0.5mph
Gradeability	45%	45%	45%	45%
Max. Wind Speed	12.5m/s	28mph	12.5m/s	28mph
Turning Radius-Inside	2.5m	8.2ft	3.66m	12ft
Turning Radius-Outside	5.5m	18ft	6.55m	21.5ft
Max. Slope	4.5° / 4.5°	4.5° / 4.5°	4.5° / 4.5°	4.5° / 4.5°
Tires Type	RT Foam-filled		RT Foam-filled	
Tires Size	355/55D 625		18-625	
POWER				
Power Source	Deutz D 2.9L4 36.4kw/48.8hp		Deutz TD 2.9L4 55.4kw/74.3hp	
Fuel Tank Capacity	100 L	26.4gal	100 L	26.4gal
HYDRAULIC SYSTEM				
Hydraulic Oil Capacity	180 L	47.5gal	180 L	47.5gal
WEIGHT				
Machine Weight (CE/ANSI)	11400kg	25132lbs	18000kg	39683lbs

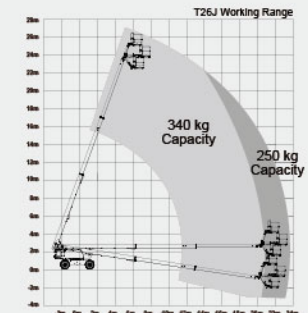
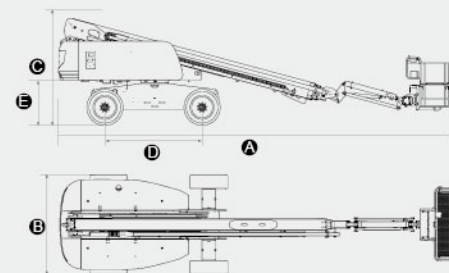



APPLICATIONS

LGMG products are used widely in industrial factories, industrial construction, road and bridge construction, aviation, shipyards and other applications.

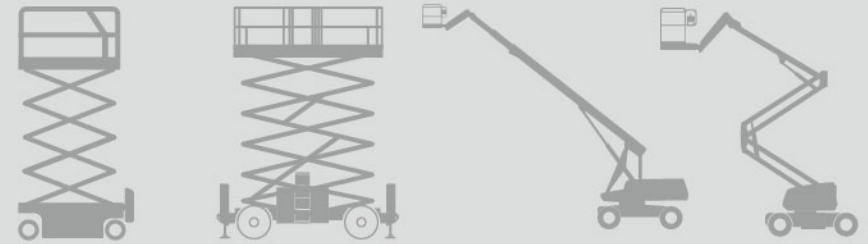

SERVICE

LGMG provides technical support, training programs, warranty and parts sales to customers during the whole machine life-cycle.



Technical support

LGMG service teams always provide remote technical support by phone or email and even on-site support with manuals, tools, information and service solutions.



Training support

LGMG provides various training programs to the operators and service technicians, helping rental companies to improve their service and training ability via dedicated courses prepared by LGMG teams either online or on-site.



Warranty and parts support

LGMG provides sufficient stock of parts both in LGMG HQ and LGMG Europe/NA locations. Accurate parts manuals and technical support teams are always available to answer your questions.

